

PÄÄMITAT

PITUUS	SUURIN	30,50 M
PITUUS	KVV	28,21 M
LEVEYS	SUURIN	8,90 M
SYVÄYS	SUURIN	3,00 M
SYVÄYS	KVV	2,80 M
SIVUKORK	PÄKKEEN	5,40 M
KONETEHO		2x290 HV
NOPEUS	KOEAJD	N. 8,5 SOLMUA
NOPEUS	HARATESSA	N. 1-3 SOLMUA

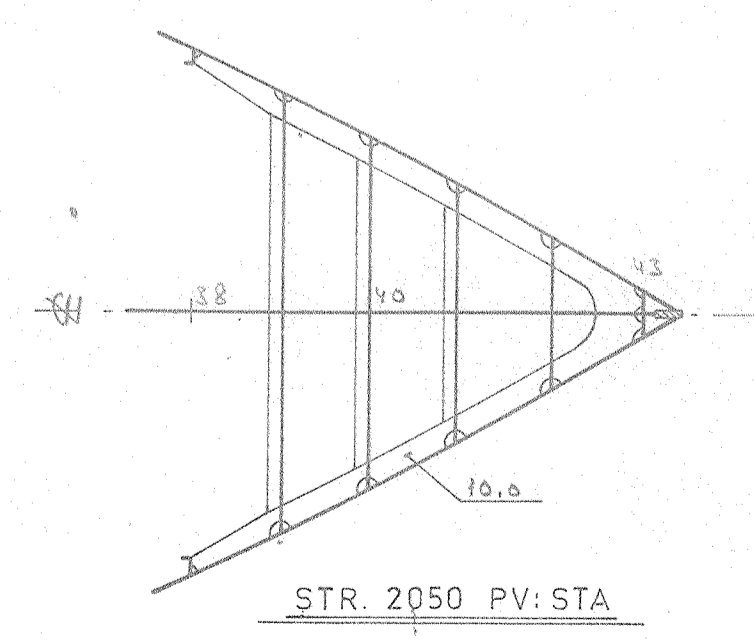
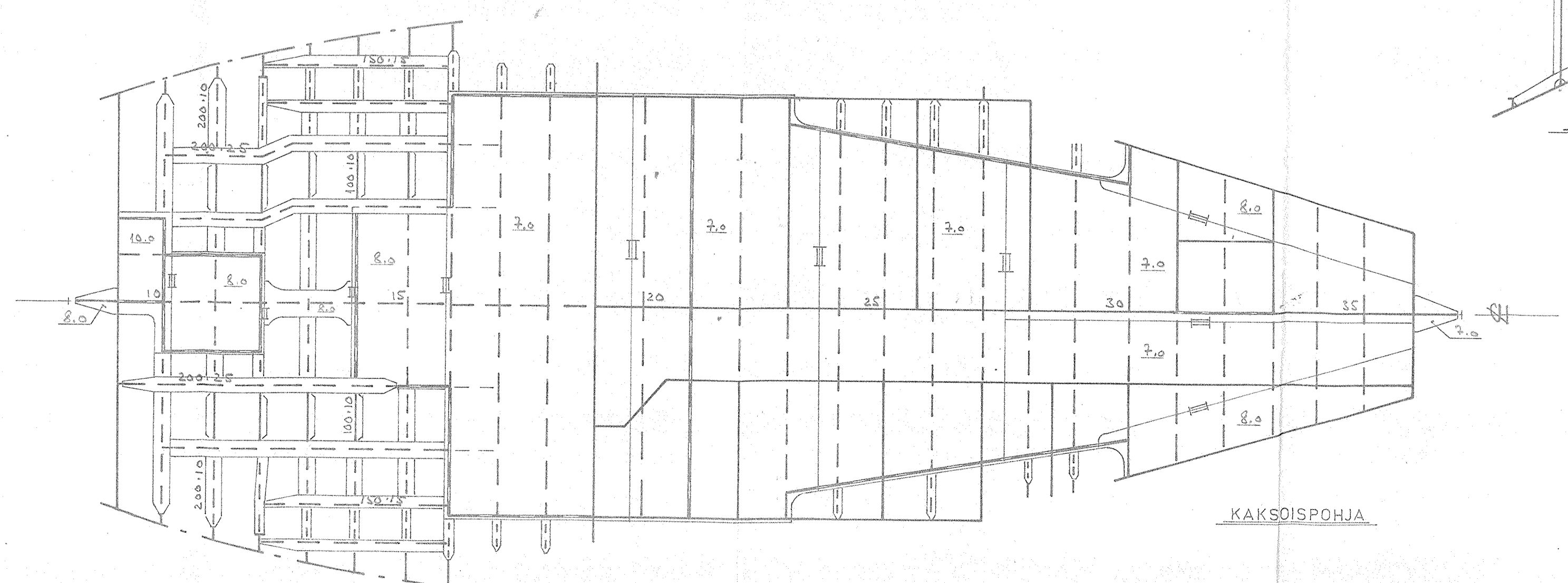
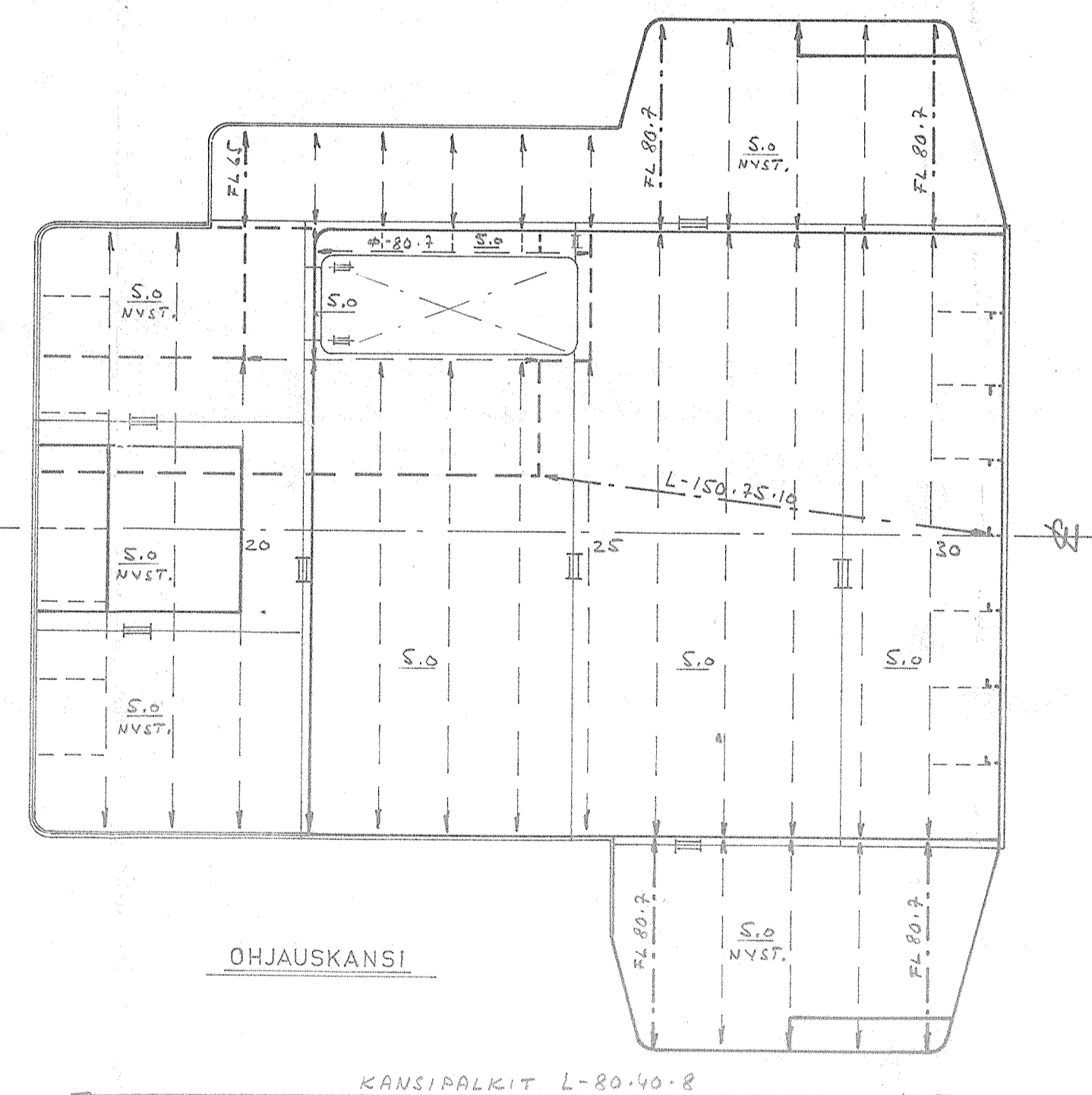
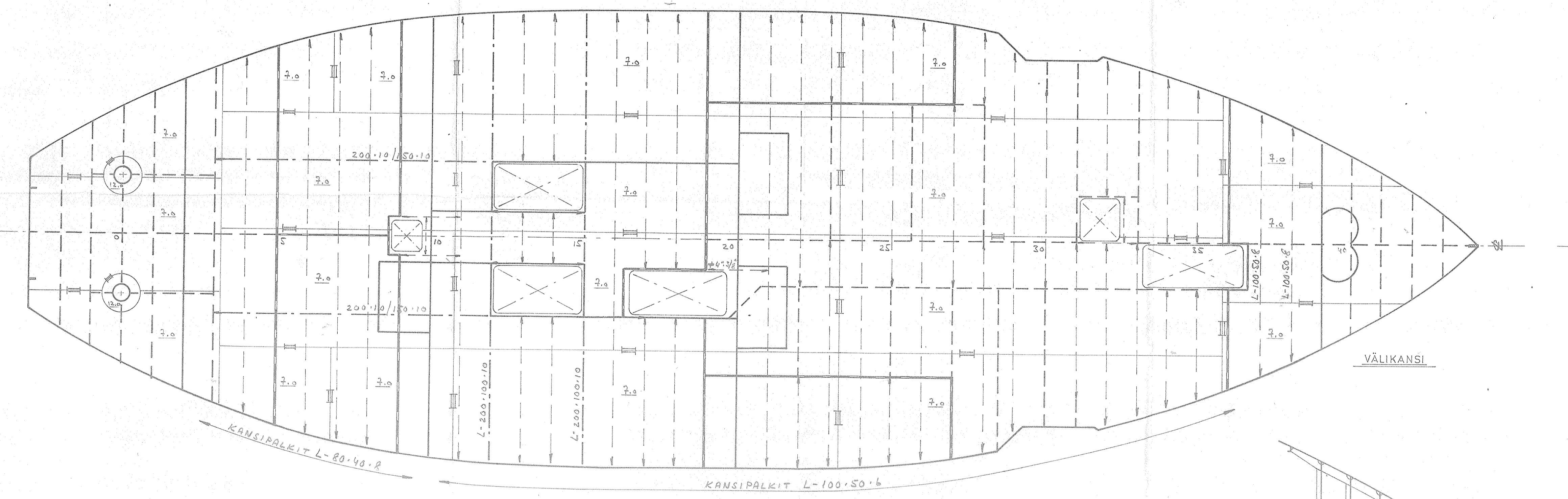
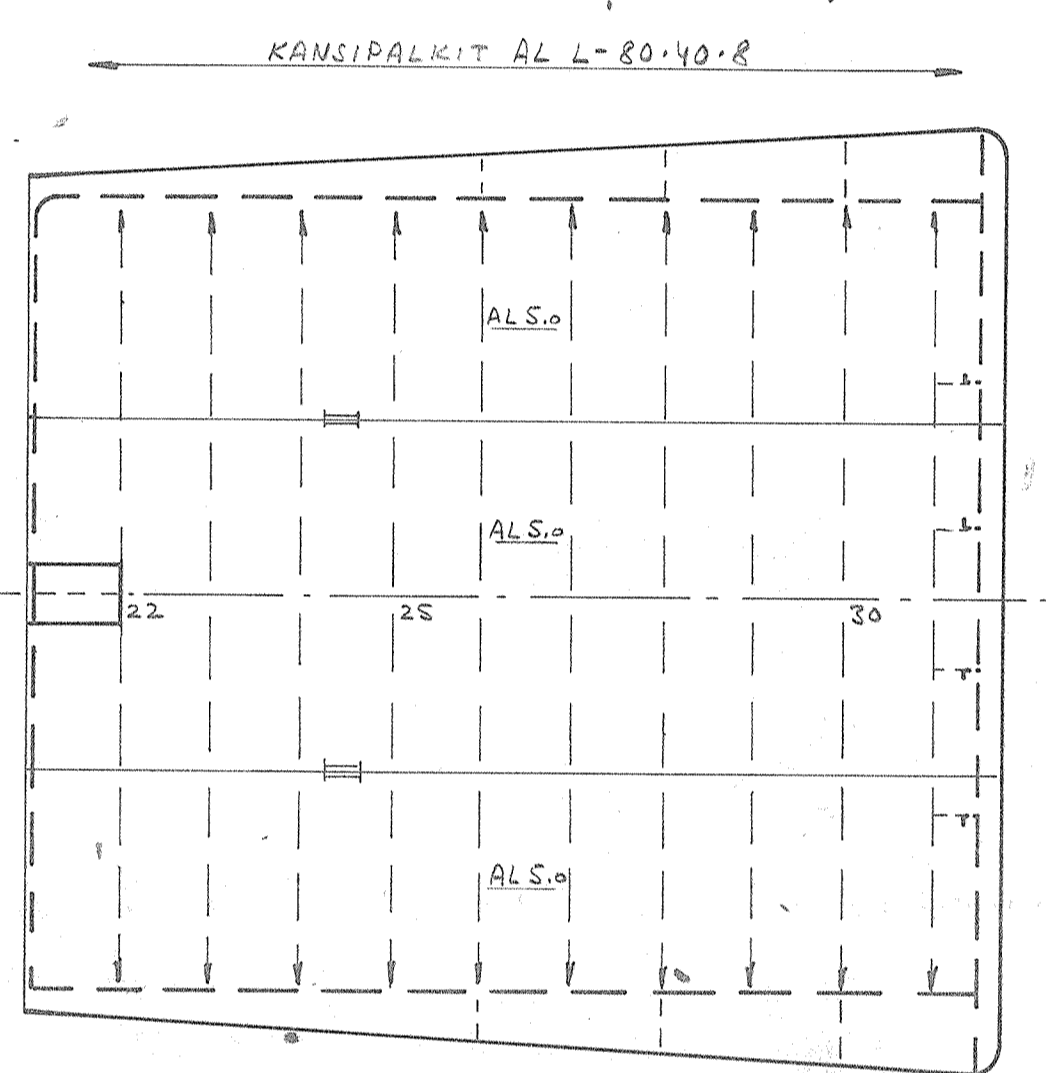
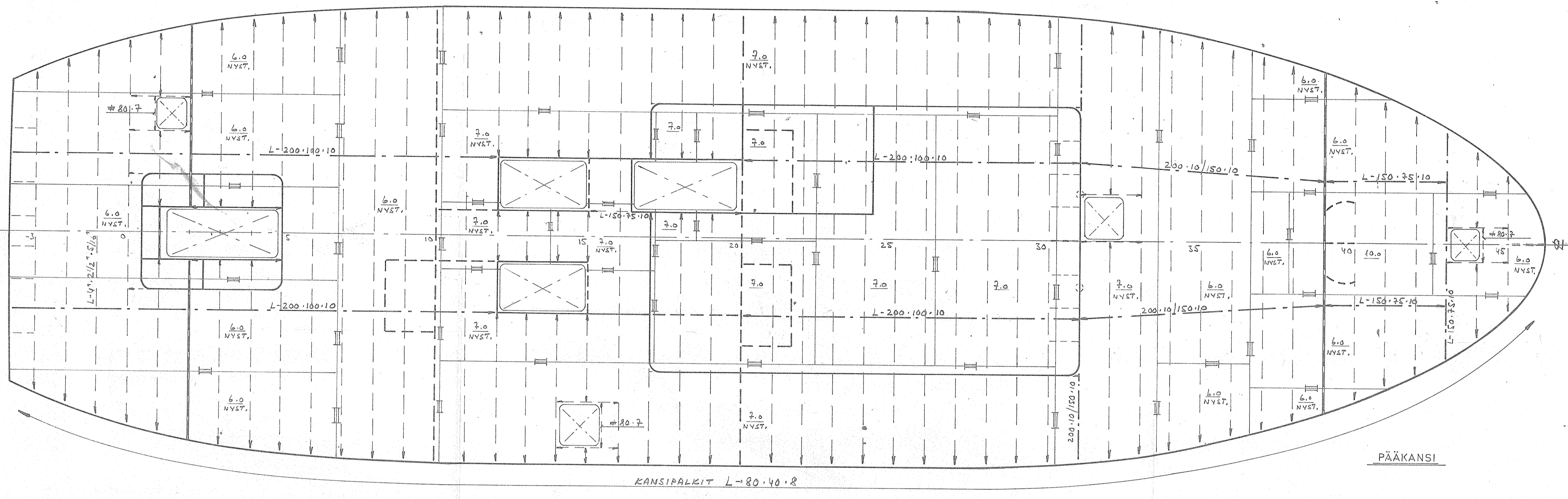
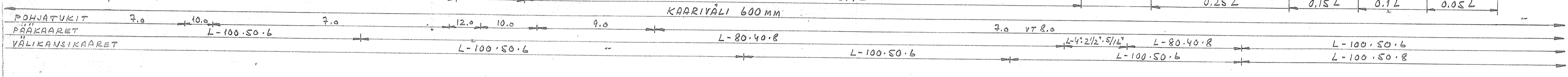

MERENMITTAUSALUS

RAUMA-REPOLA OY PÄÄSKYNIEMI	SCALE	DRAWN	3,2,72 OAS/E
OY MARINE CONSULTING AB	1:50	CHECKED	
HELSINKI FINLAND		PASSED	
PITUUSLEIKKAUS JA KANNET			P.06.112.103 A P48 CO-045A